

FAAST XT 9400X

Fire Alarm Aspiration Sensing Technology®

SPECIFICATIONS

Electrical Characteristics

External Supply Voltage	18 – 30 VDC
Remote Reset Time	External monitor must be pulled low for a minimum of 100 msec
Power Reset	1 sec
Average Operating Current	Fan High – 465mA, 11.2W Fan Med – 340mA, 8.2W Fan Low – 220mA, 5.3W
Alarm Current	Fan High – 493mA, 11.85W Fan Med – 368mA, 8.85W Fan Low – 248mA, 6W
Relay Contact Ratings	3.0A @ 30VDC, 0.5A @125VAC
Environmental Ratings	
Operating Temperature	32°F (0°C) to 100°F (38°C) – Factory tested to 131°F (55°C)
Sampled Air Temperature	-4°F (-20°C) to 140°F (160°C)
Humidity	10 to 95% non-condensing
IP Rating	IP30
Coverage Area	28,800 sq.ft. (2,676 sq.m.)
Air Movement	0 – 4,000 ft/min (0 – 1,219.2 m/min)

Exterior Dimensions

Height	13.3 in (338 mm)
Width	13.1 in (333 mm)
Depth	7.5 in (191mm)
Cable Access	4 1in (25.4mm) cable access holes on top, bottom and back of unit
Wire Gauge	12 Ga.
Pipe Size	½ or ¾ in Nom. (20 or 25mm Nom.)
Max Single Pipe Length	400 feet (123 m) <i>*other three pipes disabled</i>
Total Pipe Length	1050 ft. (320 m) <i>*designs must be verified within PipeIQ software</i>
Shipping Weight	11.8 lb (5.4 kg)

TABLE OF CONTENTS

Items Included With Unit	2	Alarm and Relay Configuration	10
Connecting to FAAST 9400X	2	Audible Indicator Configuration	10
Connecting to FAAST via USB	2	Failure of Configuration validation	10
Connecting to FAAST via Ethernet	2	Power glitch during configuration	10
Installation	3	Normal	10
Pipe Installation	3	Test	10
Physical Unit Installation	3	Sounder Test	10
Wiring	4	Reset	10
User Interface	5	Reset Airflow Baselines	11
Particulate Level Display	5	Isolation	11
Alarm Level Display	6	Disable Mode	11
Air Flow Display	6	Acclimate Mode	11
Fault Display	6	Day, Night And Weekend Mode	11
LCD User Interface	7	Logs	11
Configuration Menu Screen	9	Event Log	11
LCD Menu Screen	9	Data Trend Log	11
Language Screen	9	Message Log	11
Backlight Screen	10	External Monitor/Reset	11
Contrast Screen	10	Ethernet Connection	11
Message Log Screen	10	USB Connection	11
Set Time Screen	10	Pipe Network	11
Special mode screens	10	Web Server	12
Initialization Screen	10	Email Notification	12
Baselining Screen	10	Canned Smoke Testing	12
Firmware Upgrade Screen	10	Maintenance	12
Modes of Operation	10	Laser Safety Information	12
Initialization	10	Warranty	12
Configuration Overview	10	FCC Statement	12
Fan Speed Configuration	10		

SCOPE OF THIS MANUAL

This manual is intended as a guide for technicians to install, set up, and provide preliminary system checks for the FFAST 9400X (Fire Alarm Aspiration Sensing Technology) aspirating smoke detection system. Before installing, please read the Comprehensive Instruction Manual for FFAST (available at systemsensor.com/faast), which provides detailed information on pipe network design and system configuration.



Performance of the FFAST system depends on the designed pipe network for the site. Any alteration to the pipe network must be verified by a technician, as alterations will have an effect on system performance. The PipeIQ design tool can be used to verify the suitability of any pipe network design and subsequent alterations. The PipeIQ software can be downloaded at systemsensor.com/faast

DESCRIPTION

The FFAST 9400X aspirating smoke detection system is an advanced particulate detection system for use in very early warning and early warning detection applications, as well as standard detection in harsh environments.

The system continuously draws air from the environment (up to 28,800sqft) through a series of sampling holes to monitor the environment for smoke particulate.

FAAST system conditions are displayed at the user interface and at a fire alarm control panel using relays. System conditions can also be monitored in two ways through the network interface: integrated web server or PipeIQ software. The display provides a clear indication of the system status, particulate levels, alarm levels, air flow and fault conditions. Additionally, email notification can be sent upon device status changes. All conditions can be monitored at the device's user interface or remotely via the web.

FEATURES

- Advanced detection
 - Blue LED and IR laser technology
 - Particle separation for increased nuisance immunity and prolonged filter life
 - Dust discrimination for reduced false alarms
 - Wide sensitivity range 0.00046 to 6.25% obs/ft
- Monitors up to 28,800 sq. ft. (dependant on local codes and ordinances)
- Configurable alarm thresholds and delays
- User configurable fan speed setting
- Status At a Glance and LCD User Interface
- 8 sets of relay contacts
- Dedicated electronic filter life monitoring
- Independent dedicated ultrasonic airflow sensing per channel
- Field service access door
- Easy access filter
- Detailed operation logs storing events, sensor trend data and service messages
- Acclimate mode operation for auto-adjustment of sensitivity
- USB interface for simplified configuration and diagnostics
- Remote monitoring and diagnostics
 - Serial Modbus over RS-485
 - Modbus/TCP via ethernet
- Remote reset/dry contact input
- Multi-lingual support
- E-Mail notification of alarm, isolate, or fault conditions
- Configurable supplementary audible indicator

ITEMS INCLUDED WITH UNIT

- FFAST 9400X unit
- Mounting bracket and hardware
- Installation and Maintenance Instructions
- USB interface cable
- PipeIQ software, comprehensive manual, and other helpful documents may be downloaded at systemsensor.com/faast

CONNECTING TO FFAST 9400X

FAAST 9400X requires a program download from PipeIQ in order to initialize. This connection can be achieved using either the USB port located on the front of the device, or the Ethernet port located inside the wiring cabinet.

CONNECTING TO FFAST VIA USB

NOTE: In order to connect your computer to the FFAST using a USB connection, a USB driver must first be installed. The driver installation occurs during the installation of PipeIQ version 2.0 or later. Once the driver is installed, connect to the device using the following steps.

1. Launch PipeIQ.
2. Create a new project and select FFAST XT device, or open an existing project
3. Expand the tree view in the left side navigation pane to reveal the device
4. Right click on the device and select 'Connect Device'
5. Select USB, The USB combo box should already be populated with FFAST XT (Com Port Number).
6. Select Read only/Administrator (requires password – default is 'password') mode Click Connect.

CONNECTING TO FFAST VIA ETHERNET

Default Device IP Configuration

IP Address:	192.168.1.10
Subnet Mask:	255.255.255.0
Default Gateway:	192.168.1.1
Primary DNS:	0.0.0.0
Secondary DNS:	0.0.0.0

CONFIGURE YOUR PC

Your PC will need to be on the same local area network as the FFAST device in order to establish communication. Change your PC's IP address to 192.168.1.15 by:

(Important Note: Before changing your PC's IP address, be sure to take note of whether your IP is currently dynamically set, or is a static IP address. If your PC is assigned a static IP address, make note of the IP address and subnet mask so that you can change back to the proper settings after the FFAST is configured.)

- 1 – Accessing your network setting in your PC's control panel
- 2 – Open 'Local Area Connection' settings and select 'Properties'
- 3 – Select 'Internet Protocol Version 4 (TCP/IPv4) and then select 'Properties'
- 4 – Select 'Use the following IP address and enter 192.168.1.15. If the subnet mask does not automatically populate, enter 255.255.255.0 into the subnet mask field.
- 5 – Hit Okay and close out of the network menus.

CONNECT USING PIPEIQ

- 1 – Launch PipeIQ. (PipeIQ may be downloaded from systemsensor.com/faast)
- 2 – Create and save a new project, or open an existing project
- 3 – Expand the tree view in the left side navigation pane to reveal the device
- 4 – Right click on the device and select 'Connect Device'
- 5 – Change the User field to 'Administrator' and enter the password – the default password is 'password' – then hit 'Connect'
- 6 – Upon connection, a green check will appear next to the device in the navigation tree
- 7 – Revert to initial settings

INSTALLATION

This equipment must be installed in accordance with all local and national codes and regulations.

PIPE INSTALLATION

The pipe layout is designed using the PipeIQ software package. Refer to the Comprehensive Instruction Manual to design the pipe network. All pipe must be installed in accordance with local and national codes and regulations. The pipe network should be complete before proceeding with the physical and electrical system installation.

PHYSICAL UNIT INSTALLATION

WARNING

Make sure that there are no pipes or electrical wires within the wall before drilling any mounting holes

SECURING THE MOUNTING BRACKET

The typical mounting location for the FAAST unit is on the wall. The unit is mounted to the wall using the enclosed mounting plate. Figure 1 shows the wall mounting plate. For easier access to the FAAST unit, it is preferred to position the mounting plate in an easily accessible location.

1. Place the mounting bracket on the wall in the desired location and use it as a template to locate the necessary mounting holes.
2. Mark the hole locations and remove the bracket. It is recommended to secure the bracket using the 4 outer mounting holes.
3. Using a drill and the proper size bit for your mounting hardware, drill the necessary holes.
4. Use appropriate fasteners to accommodate the mounting surface and FAAST device weight.
5. Secure the bracket to the wall.

FIGURE 1: WALL MOUNTING PLATE

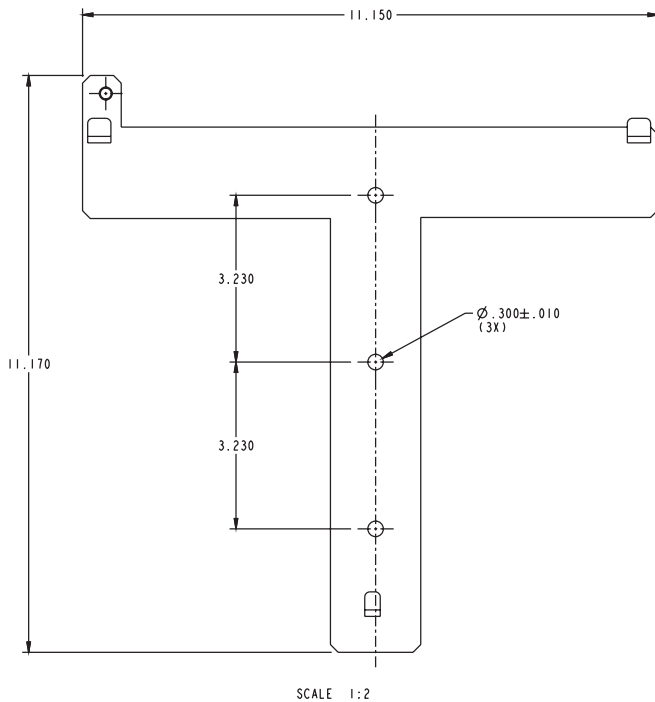

ASP115-00

MOUNTING THE DETECTOR TO THE BRACKET

Once the mounting plate is attached, the unit is ready to be mounted on to the plate. Perform the following procedure to mount the unit.

1. Before installing the unit onto the bracket, remove the appropriate conduit caps from the top or bottom left side of the unit to match the orientation of the wiring. See Figure for location of the wiring access plugs.
2. Line up the unit with the four mounting clips and the mounting studs on the left side.
3. Push the unit down onto the mounting clips and secure it with the supplied washer and nut on at least one of the two mounting studs protruding through the mounting slots shown in Figure 2.

FIGURE 2: MOUNTING SLOTS FOR MOUNTING STUDS

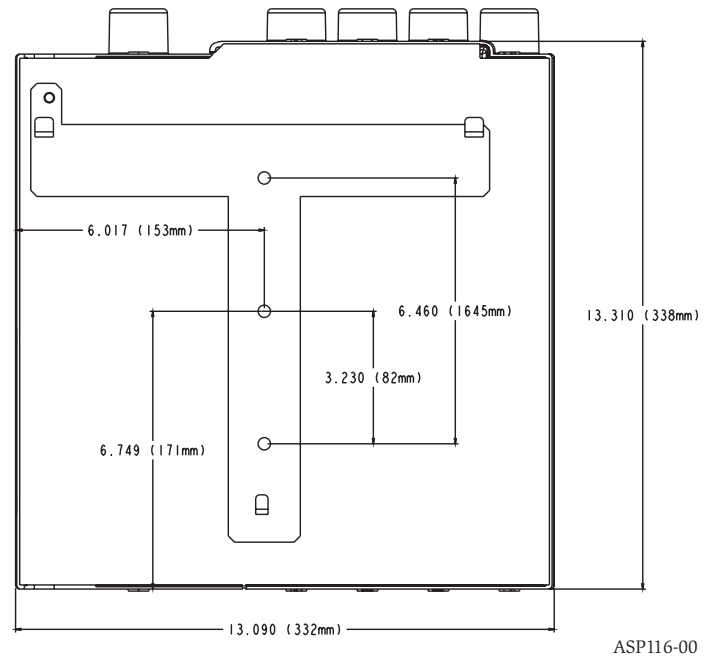

CONNECTING THE AIR SAMPLING PIPE

ATTENTION

Detailed pipe network information and best practices can be found in the Pipe Installation Guide, available for download at systemsensor.com/faast

The input and output ports are designed to accept nominal one inch pipe (25mm). The input and output ports are tapered to provide fast, easy, push-fit connection of the sampling pipe to the unit. Perform the following procedure to connect the air sampling pipe to the unit.

1. Square off and de-burr the end of the sampling pipe. Ensure that the pipe is free from any particles that might interfere with the pipe connection.
2. Remove the input plug from the input port being used (either the top or bottom of the unit).
3. Inset the air sampling pipe into the port, ensuring a snug fit. DO NOT glue these pipes.

EXHAUST PIPE

The device must always be exhausted in to the space that it is monitoring. There are some circumstances where it may be necessary to connect a pipe to the exhaust port to divert the exhaust away from the location of the unit. Adding as little as 2ft of exhaust pipe also acts as a muffler for the fan - ensuring quieter operation. The output ports are tapered the same as the input ports, to provide fast, easy, push-fit connection of an exhaust pipe to the unit. Perform the following procedure to connect the exhaust pipe to the unit.

1. Square off and de-burr the end of the sampling pipe. Ensure that the pipe is free from any particles that might interfere with the pipe connection.
2. Remove the input plug from the input port being used (either the top or bottom of the unit).
3. Insert the air sampling pipe into the port, ensuring a snug fit. DO NOT glue these pipes.

WIRING



Before working on the FAAST system, notify all required authorities that the system will be temporarily out of service. Make sure all power is removed from the system before opening the unit. All wiring must be in accordance with local codes.

POWER CABLES

Use the power ratings of the unit to determine the required wire sizes for each connection. Use the power ratings of the connected products to determine the wire size.

CONDUIT USAGE

If electrical conduit is used for system wiring, terminate the conduits at the cable entry ports on the top or bottom of the unit, using the appropriate conduit connectors.

1. Run all wiring, both power and alarm, through the conduit and into the left side of the unit enclosure, as seen in Figure 3.
2. Attach the appropriate wires to the supplied Euro connector. Follow appropriate local codes and electrical standards for all cabling.
3. Plug the appropriate connector into the mating connector on the unit.

FIGURE 3. POWER AND ALARM CONNECTION BLOCK

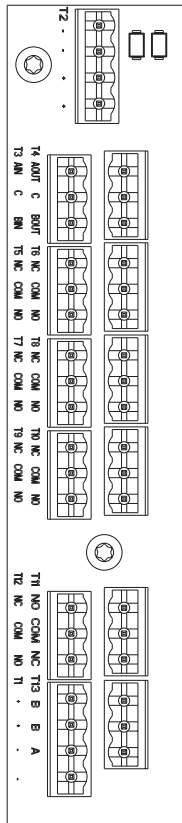

ASP114-01

CABLING REQUIREMENTS

The FAAST system provides a series of Euro style pluggable terminals, located behind the left side door of the unit. Refer to Table 1 for the proper electrical connections to the unit. Refer to Table 2 for a typical connection for monitoring the FAAST system at a Fire Alarm Control Panel (FACP).

TABLE 1. TERMINAL DESIGNATIONS

NAME	TERMINAL BLOCK	NOTES
External Power -	T1	Powers Aspirating Smoke Detector
External Power -		
External Power +		
External Power +		
SLC +	T2	Not used on conventional models
SLC +		
SLC -		
SLC -		
A IN	T3	RS-485 Rx
C		Rx and Tx can be wired in a half duplex configuration
B IN		
A OUT	T4	RS-485 Tx
C		Rx and Tx can be wired in a half duplex configuration
B OUT		
Alert NO	T5	Maintains state on loss of power
Alert COM		
Alert NC		
Action 1 NO	T6	Maintains state on loss of power
Action 1 COM		
Action 1 NC		
Action 2 NO	T7	Maintains state on loss of power
Action 2 COM		
Action 2 NC		
Fire 1 NO	T8	Maintains state on loss of power
Fire 1 COM		
Fire 1 NC		
Fire 2 NO	T9	Maintains state on loss of power
Fire 2 COM		
Fire 2 NC		
Minor Fault NO	T10	Maintains state on loss of power
Minor Fault COM		
Minor Fault NC		
Urgen Fault NC	T11	Always reverts to reset on loss of power
Urgent Fault COM		NO, NC designations are with power applied and unit operating without fault.
Urgent Fault NO		
Isolate NO	T12	
Isolate COM		
Isolate NC		
External Monitor	T13	

FIGURE 4. FACP WIRING DIAGRAM

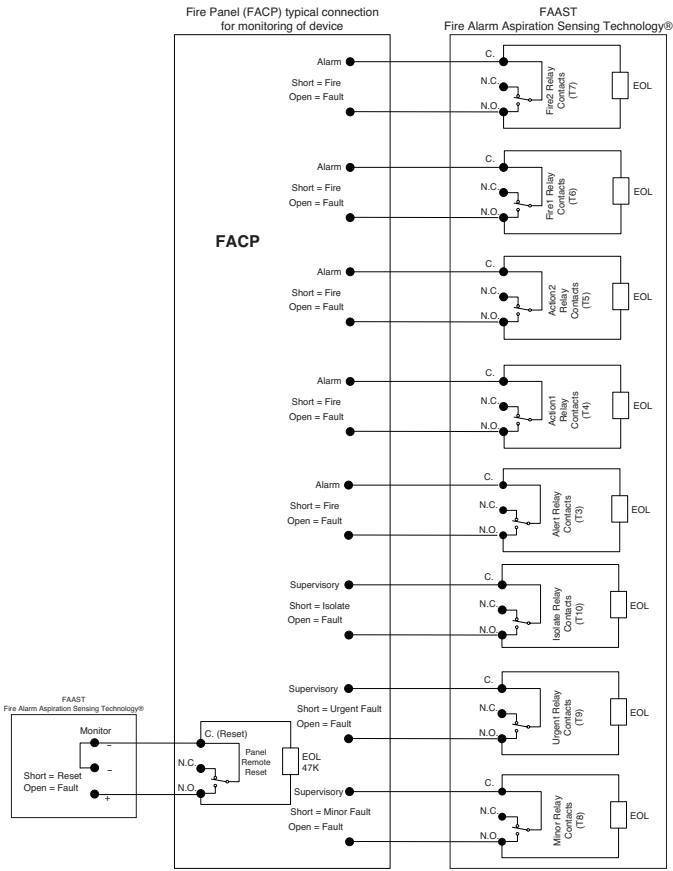

ASP18-17

SYSTEM POWERING

The following procedure describes how to initially power up the FAAST system.

1. Unplug the unit’s power connector to the unit before turning on the power.
2. Turn on the power.
3. Check the voltage at the connector. Make sure it is within the required voltage range.
4. If the voltage is within the proper range, reconnect the power connector to the unit.
5. Verify the system fan starts up and air begins to flow out of the exhaust port. The user interface will provide the device status.
6. Connect a computer, with PipeIQ installed, to the unit using either the USB connection on the front of the device, or the Ethernet port located in the left side wiring door. (See the ‘Connecting to FAAST 9400X’ for detailed connection instructions.)
7. Use the PipeIQ software to set up the unit configuration required for the particular application.
8. The PC may now be disconnected unless a permanent networked connection is desired. (Permanent connection of RJ45 connector is not allowed if used in a Class I, Division II hazardous location).
9. The device will establish an airflow baseline during the first five minutes of operation. After five minutes, the airflow level display will provide the true measured airflow status. The device will give visual indication of the baslining period on the LCD screen.

USER INTERFACE

The user interface, shown in Figure 5, provides the following information:

- Detector status: Normal, Alarm, General Fault, Isolate Fault, Disable Fault, Voltage Fault
- Alarm Level: Alert, Action 1, Action 2, Fire 1, Fire 2
- Particulate Level: 1 – 10 relative to Alert
- Flow level for each pipe inlet
- LCD for device test, service, and monitoring.

FIGURE 5. USER INTERFACE DISPLAY

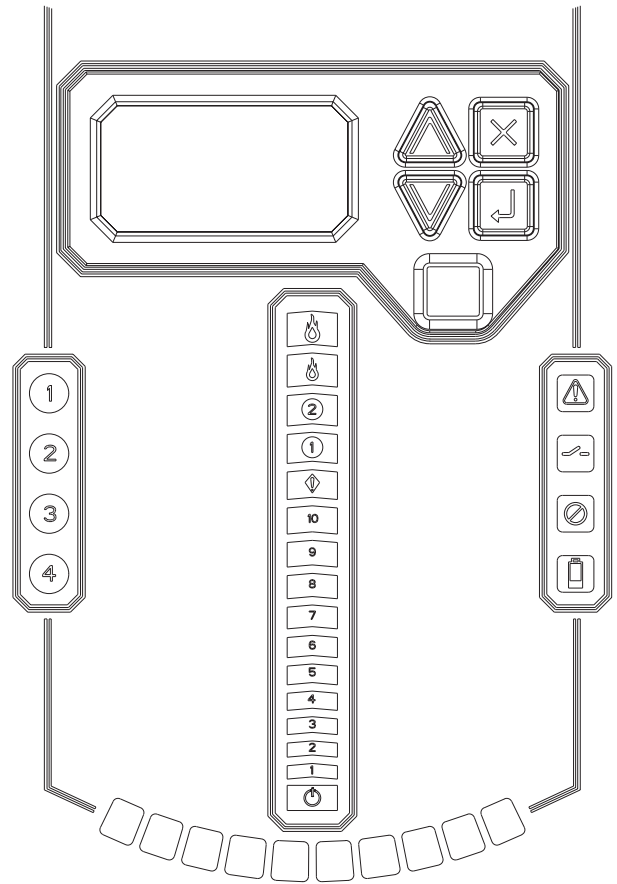

ASP117-00

PARTICULATE LEVEL DISPLAY

The particulate level display, shown in Figure 6, consists of ten amber LEDs that correspond to the current level of the particulate level detected. The LEDs illuminate in order from Level 1 to Level 10, starting from the bottom of the display and moving up as the particulate level increases. Each LED represents a 10 percent increment in the particulate level relative to the Alert level.

FIGURE 6. PARTICULATE LEVEL DISPLAY

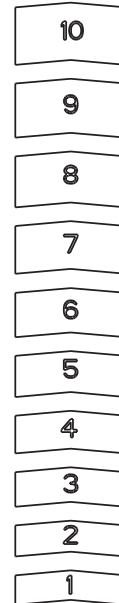

ASP118-00

ALARM LEVEL DISPLAY

The alarm level display consists of five red LEDs that correspond to the current alarm level, shown in Figure 7. These LEDs are located directly above the particulate level LEDs. They illuminate sequentially upward as the severity of the alarm increases. These alarm levels are configured at default levels when shipped. They may be modified using the PipeIQ software. Each of these alarm levels controls a set of form C relay contacts. When an alarm level threshold has been crossed, the corresponding Alarm LED illuminates and the relay activates a signal. These alarm thresholds and associated relay outputs can be configured for either latching or non-latching operation. Each Alarm output has a configurable delay from 0 to 60 seconds.

FIGURE 7. ALARM LEVEL DISPLAY



ASP119-00

AIR FLOW DISPLAY

The FAAST system uses independent dedicated per channel ultrasonic airflow sensing and displays the status in real time on the user interface. The air flow display consists of 4 bi-color LEDs at the center left of the user interface, numbered 1, 2, 3, 4 – corresponding to each pipe inlet, and 10 green LEDs at the bottom of the device to display current flow balance as shown in Figure 8. The unit will cycle through the four pipe inlets, changing to the next inlet every 2 seconds. The number corresponding to the inlet currently being displayed on the air flow pendulum will be illuminated green.

The green segments on the air flow pendulum indicate how close the current air flow is to a high or low fault threshold. The default threshold for a fault condition is + or - 20% from airflow baseline. This fault threshold is configurable using the PipeIQ software. During normal operation two adjacent indicators are green and correspond to the current air flow entering the detector for the inlet being displayed. When air flow is balanced, these two indicators will be centered in the pendulum. As air flow increases or decreases, the indicators will move to the left in the case of a low flow condition, or right in the case of a high flow condition. A flow fault occurs within 3 minutes of reaching the fault threshold and the minor fault relay is set. If the detected airflow is greater or less than 50% of normal, the urgent fault relay is set. During a fault condition, the pipe inlet indicator with the worst case flow scenario will illuminate amber, and the flow display will display that channel's flow level only.

Detailed air flow information can also be read by accessing the 'Air Flow' menu in the device's LCD display.

FIGURE 8. AIR FLOW INDICATION

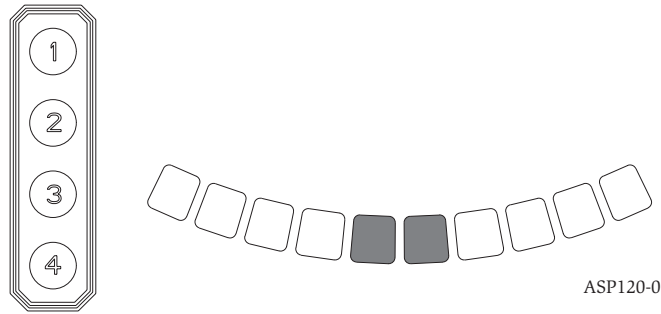

ASP120-00

FAULT DISPLAY

The FAAST user interface displays faults in two ways, through amber LEDs on the right side of the user interface, and also on the LCD screen. The four LED faults are as follows:

FIGURE 9. FAULT DISPLAY

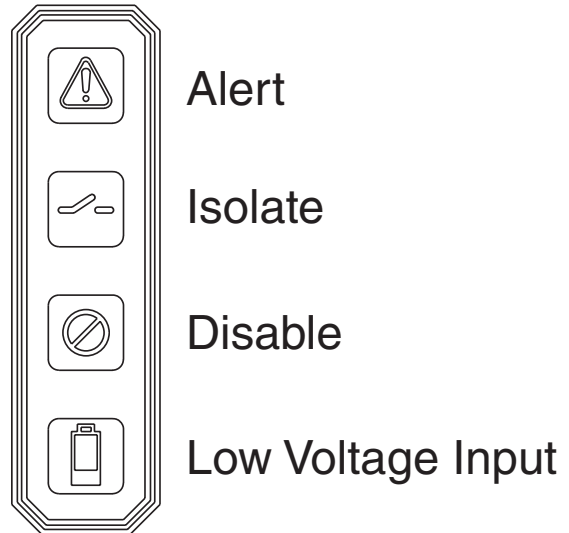

ASP122-00

If the General Fault LED is illuminated, the fault condition will be shown on the LCD display under the Active Faults menu. The possible fault conditions are as follows:

TYPE	DESCRIPTION	ACTIVATED RELAY
Low Flow Fault	Device has decrease airflow as defined by the user programmable boundary.	Minor Fault
	Device has decrease airflow of 50%	Urgent Fault
Configuration	Configuration of device with configuration software has failed.	Minor Fault
	Device was interrupted with a power loss during configuration. A Reset will clear this fault and device will revert back to it's last good configuration.	Minor Fault
	Device is new and has not been configured.	Urgent Fault
	Device has corrupt configuration and is unable to operate.	Urgent Fault
Drift Blue Fault	Device blue signal has reached the long term drift limit.	Minor Fault
IR Laser Drift Fault	Device IR Laser signal has reached the long term drift limit.	Urgent Fault
Sensor Fault	Device sensor is not working and requires immediate replacement	Urgent Fault
External Monitor Fault	External monitor detects open.	Minor Fault
Time Base Fault	Internal Time base needs updating.	Minor Fault
Aspirator Fault	Indicates the fan has stopped working and requires immediate attention.	Urgent Fault
Filter Fault	Device filter is clogged and requires replacement	Minor Fault
	Device filter is clogged and has not been replaced 72 hours after giving the Filter Fault with Minor Fault Relay set	Urgent Fault
Disable Fault	Device has been put in disable mode.	Isolation Fault
Isolation Fault	Device has been put in isolate mode.	Isolation Fault
High Flow Fault	Device has Increase airflow as defined by the user programmable boundary.	Minor Fault
	Device has decrease airflow of 50%	Urgent Fault
Low Voltage Fault	Device Input voltage is low	Urgent Fault

LCD USER INTERFACE

The FAAST XT has an LCD screen to provide detailed information of the devices status and configuration. The LCD typically will be in an idle state where the screen is off. The LCD will enter a sleep state if a single screen has remained unchanged for a period of 30 seconds. A single push of any button will wake the screen up and the home screen will be displayed. Once the LCD is on, navigation through the menus is done with the buttons on the right hand side.

FIGURE 10. LCD DISPLAY

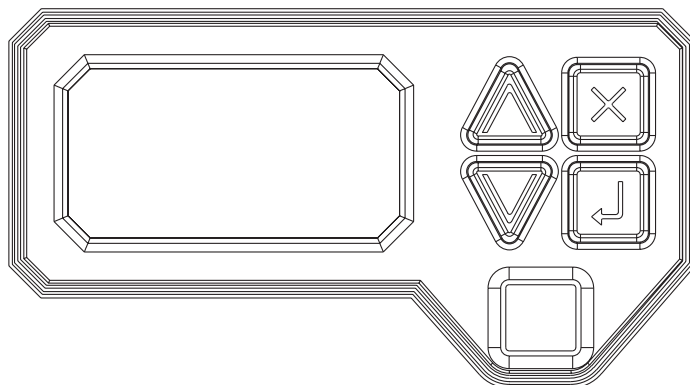

ASP121-00

BUTTON	FUNCTION
	Scroll up or down through the LCD menus
	Select or enter highlighted item on the LCD screen
	Cancel, Back or Escape from current menu selection.

The LCD interface supports multiple languages. LCD language display is set using PipeIQ or can be changed by accessing the settings menu in the LCD menus.

HOME SCREEN

The Home screen is the default screen that is initially shown when the LCD is activated. The screen will show the device's current state which includes, local address, date, time, current percent of smoke, and the highest priority state.

FIGURE 11. HOME SCREEN

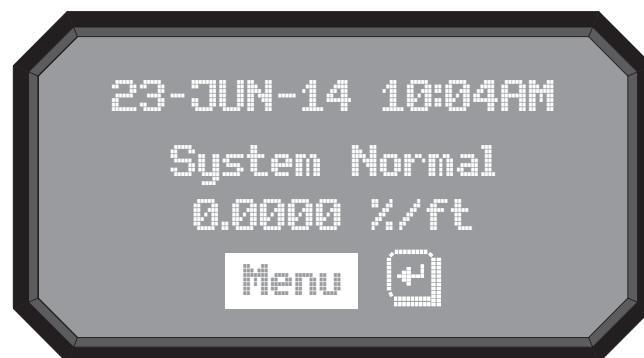

ASP112-00

The menu option is available from the home screen. Pressing the select button will enter the main menu screen. If the device's sounder is active then the only available selection will be Silence. Pressing the select key will silence the sounder and then the menu option will appear.

MAIN MENU SCREEN

The Main Menu screen shows the options for more detailed information on the device. The available options are:

OPTION	DESCRIPTION
Active Faults	Information on all active faults
Air Flow	Flow change percentage for all four channels.
Functions	Enter to select, test, isolate, disable, reset baseling functions
Event History	View event history
Configuration	View current configuration of the device
LCD Settings	Adjust language setting for LCD, contrast
Message Log	View message log history
Set Time	Set local time on device
Diagnostics	View diagnostics

ACTIVE FAULTS SCREEN

Only the highest priority fault is shown on the home screen, but it is possible for a device to have more than one fault. These faults can be seen with the Active Faults screen. The screen displays all active faults from highest to lowest priority. The priority fault level is as follows:

PRIORITY	FAULT	NOTES
1	Disable	
2	Isolate	
3	Configuration	
5	Sensor	
6	Aspirator	
7	Internal	Internal HW/Sw failure
8	Low Voltage	
9	High Flow (Ch. 1-4)	
10	LowFlow (Ch. 1- 4)	
11	Filter	
12	External Monitor	Conventional devices only
13	Time	

AIR FLOW SCREEN

The Air Flow screen shows the level of air flow change as a percentage for each channel and the programmed boundary level. There is also a bar graph to for each channel to provide a visual indication of how close the flow is to a boundary level. If not all channels are being used the screen will display 'Disabled' next to the channel.

FIGURE 12. AIR FLOW SCREEN

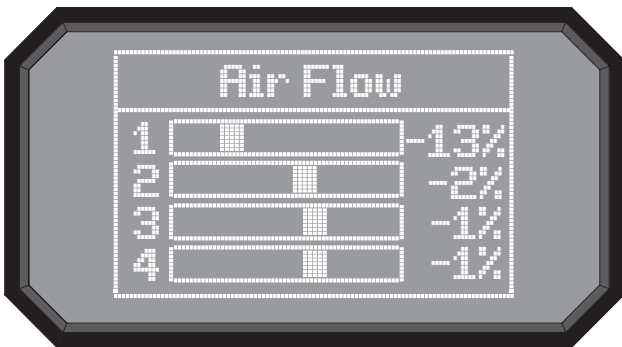

ASP111-00

FUNCTIONS MENU SCREEN

The Functions menu screen is used to change the device’s state or activate test mode. Because this menu allows the user to change the device out of its normal operating state there is an optional lock out feature for this menu. The lockout requires a 4-digit passcode to enter the functions menu – this passcode is set using the PipelQ Software. When the functions menu is accessed from the main menu screen with the lock feature enabled, the enter password screen will be displayed.

FIGURE 13. FUNCTIONS MENU SCREEN

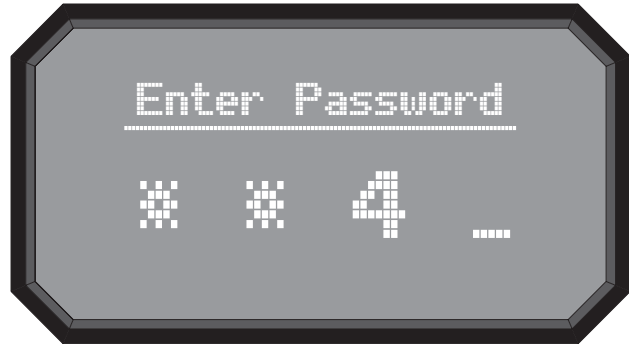

ASP123-00

The scroll (Δ▽) keys are used to increment or decrement the number for the digit the cursor is on. To enter the number use the select (←) key and the cursor will advance to the next digit. When the last digit is entered the Functions menu will be displayed if the password was entered correctly. If the password does not match the display will show Password Invalid for 3 seconds and then return to the home screen.

From the functions menu the following options are available:

- Isolate
- Disable
- Reset
- Reset Baselines
- Test
- Sounder Test
- Reset IP Network

ISOLATE SCREEN

The Isolate function will set the device into the isolate mode. When this function is selected from the functions menu the device will display that Isolate mode will be activated and will ask for a confirmation. Use the scroll (Δ▽) keys to select cancel or ok and then select (←) key to confirm the selection.

DISABLE SCREEN

The Disable function will set the device into the Disable mode. When this function is selected from the functions menu the device will ask for confirmation. Use the scroll (Δ▽) keys to select cancel or ok and then select (←) key to confirm the selection.

RESET SCREEN

The Reset function will reset the device. When this function is selected from the functions menu the device will ask for confirmation. Use the scroll (Δ▽) keys to select cancel or ok and then select (←) key to confirm the selection.

RESET BASELINES SCREEN

The Reset Baseline function will set the device into the Reset Baseline mode. When this function is selected from the functions menu the device will ask for confirmation. Use the scroll (Δ▽) keys to select cancel or ok and then select (←) key to confirm the selection.

TEST SCREEN

The Test function will set the device into the Test mode. When this function is selected from the functions menu the device will ask for confirmation. Use the scroll (Δ▽) keys to select cancel or ok and then select (←) key to confirm the selection.

SOUNDER TEST SCREEN

The Sounder Test function will set the device into the Sounder Test mode. When this function is selected from the functions menu the device will ask for confirmation. Use the scroll (Δ▽) keys to select cancel or ok and then select (←) key to confirm the selection.

After confirmation the tones will be exercised on the sounder. Since the sounder is configurable the screen will display which tone it is currently giving (fault or alarm).

RESET IP NETWORK SCREEN

The Reset IP Network function will set the device into the Reset IP Network mode. When this function is selected from the functions menu the device will ask for confirmation. Use the scroll (Δ▽) keys to select cancel or ok and then select (←) key to confirm the selection.

EVENT HISTORY SCREEN

The event history can be viewed through the LCD screen. The Event History screen displays the event number currently being displayed, the total number of events available, and the event detail for the currently displayed event. Use the scroll (Δ▽) keys to advance up or down through the events.

CONFIGURATION MENU SCREEN

The Configuration menu provides access to view how the device is specifically configured from PipeIQ. Because this menu contains potentially sensitive information, such as email addresses, there is an optional lockout feature on this menu. The lockout requires a user to enter a 4 digit access code to enter the Functions menu. This four digit access code is configurable through PipeIQ. When a user selects the Functions menu from the main menu screen with the lock feature enabled, the enter password screen will be displayed. All configuration data is read only. From the main configuration menu the following selections are available:

- Information
- General Settings
- Relays & Thresholds
- Network
- Email

Use the scroll (Δ▽) keys to select an option and then select (←) key to confirm the selection.

INFORMATION SCREEN

The Information screen provides the text information that is configured on the device from PipeIQ. The fields include Facility name and location, device location, and contact person. Use the scroll (Δ▽) keys to advance up or down through the information.

GENERAL SETTINGS SCREEN

The General Settings screen provides the miscellaneous settings that are configured. The following configuration settings can be seen under the general settings:

- Acclimate enable
- Fan speed
- Air flow boundary
- Air flow delay
- Trend recording period
- Local address
- Sounder Alarm tone
- Sounder Fault tone
- Software Revision

RELAYS AND ALARMS MENU SCREEN

The Relays & Alarms menu screen provides the options for a detailed look of the relay and the alarm settings in the device. Use the scroll (Δ▽) keys to select an option and then select (←) key to confirm the selection.

RELAYS SETTINGS SCREEN

The Relay Settings screen shows the latching setting for each relay. A latching relaying will have an X in the box.

ALARM THRESHOLDS SCREEN

The Alarm Thresholds screen shows the five alarm levels. To get detailed information on an alarm level use the scroll (Δ▽) keys to select an option and then select (←) key to confirm the selection.

ALARM DETAIL SCREEN

The Alarm Detail screen shows the threshold values for day, night and weekend modes, or if the device is in acclimate mode it will display the acclimate boundary levels.

NIGHT MODE SCREEN

The Night Mode screen shows the start and end time for night mode and the start and end time for daylight savings time. Use the scroll (Δ▽) keys to advance up or down through the time listings.

ALARM DELAYS SCREEN

The Alarm Delays screen shows the alarm delay time in seconds for each alarm level.

NETWORK SCREEN

The Network screen provides the Mac address of the device and the TCP/IP network settings in the device.

EMAIL MENU SCREEN

The Email menu screen provides the options for a detailed look of the email settings in the device. Use the scroll (Δ▽) keys to select an option and then select (←) key to confirm the selection.

DEVICE ACCOUNT SCREEN

The device account screen shows the device's sender account and SMTP server.

EMAIL ADDRESSES SCREEN

The email addresses screen shows the currently configured email addresses that are to receive emails from the device. To see what types of messages for each email address use the scroll (Δ▽) keys to select an email and then select (←) key to confirm the selection.

EMAIL DETAIL SCREEN

The email detail screen shows the full email address and the messages that the email address is configured to receive.

LCD MENU SCREEN

The LCD settings menu allows the user to adjust the language, backlight, and contrast settings for the LCD. This feature can be locked out and require the user to enter a 4 digit access code to enter the LCD menu. This four digit access code is configurable through PipeIQ. When a user selects the LCD Settings menu from the main menu screen with the lock feature enabled, the enter password screen will be displayed. Once in the settings menu use the scroll (Δ▽) keys to select an option and then select (←) key to confirm the selection.

LANGUAGE SCREEN

The Language screen allows the user to change the language on the LCD. Languages available:

- English
- Chinese (Simplified)
- Dutch
- Finnish
- French
- German
- Hungarian
- Italian
- Norwegian
- Brazilian Portuguese
- Russian (Cyrillic)
- Spanish
- Swedish

To change language setting use the scroll (Δ▽) keys to select a language and then select (←) key to confirm the selection.

BACKLIGHT SCREEN

The Backlight screen is used to adjust the brightness of the backlight. Use the scroll ($\Delta\nabla$) keys to increase and decrease the backlight brightness.

CONTRAST SCREEN

The Contrast screen is used to adjust the contrast of the text. Use the scroll ($\Delta\nabla$) keys to increase and decrease the contrast.

MESSAGE LOG SCREEN

The Message Log history can be viewed through the LCD screen. The Message Log screen displays the message number currently being displayed, the total number of messages available, and the message. Use the scroll ($\Delta\nabla$) keys to advance up or down through the message logs.

SET TIME SCREEN

The Set Time screen allows the user to set the time and date of the device. This feature can be locked out and require the user to enter a 4 digit access code to enter the set time menu. When first entering the screen the hour time will be highlighted. Use the scroll ($\Delta\nabla$) keys to change the value. When the desired hour is selected use the select (\leftarrow) key to set the hour and the cursor will advance to the minutes. As each field is set the cursor will progress until it reaches the end. After the year is set the cursor will cycle back to the hour.

SPECIAL MODE SCREENS

Special mode screens are displayed temporarily when a specific action or unique operation mode is currently active.

INITIALIZATION SCREEN

The Initialization screen appears when the device is first powering up. It will last for 10 to 15 seconds when the device is first powered on.

BASELINING SCREEN

The baselining screen appears for the first 5 minutes after the device has initialized and indicates that the active air channel and filter flow levels are currently being observed to determine the baseline. This screen will also appear when a reset baseline is done.

FIRMWARE UPGRADE SCREEN

When a firmware upgrade is in progress the LCD will display the Firmware Upgrade in progress screen with a progress bar, and a warning to not remove power.

MODES OF OPERATION

INITIALIZATION

When the FFAST system is initially powered up it is not configured, a fault indication is set with the General Fault LED and the LCD home screen displaying a configuration fault. This will indicate that the device has not had its initial configuration loaded and will remain in this fault state until a configuration is sent to the device. Once the device is configured, or upon reconfiguration, the device will perform an initialization. This initialization will set the air flow baseline and the filter clogged baseline. It is important that the system is connected properly to the pipe network and the filter is installed properly when the device is initialized as these baselines will be used to indicate when a fault should occur. During the initialization period the device will operate as normal with the exception that flow and filter faults will not be indicated until the baseline is set. Establishing the baseline takes approximately five minutes.

CONFIGURATION OVERVIEW

FFAST XT is configured using PipeIQ. Data is sent via a built in Ethernet connection or through the USB interface located on the front of the device. The device will receive the configuration and will perform a validation before the configuration becomes active. After validation of the data the device will perform an initialization with the new configuration. If there is a problem with the configuration data the device will indicate a Configuration Fault on the user interface and will set the Urgent Fault relay. The device will require a new configuration before operating properly.

FAN SPEED CONFIGURATION

The device is capable of running at 3 different fan speeds to help power consumption for the area of coverage. To minimize power the lowest fan speed should be chosen. The fan speed directly affects the performance of the device. Therefore, when creating a pipe layout the calculations that are performed are based on the fan setting. If the fan setting is changed on the device at a later date the pipe system must be re-verified.

ALARM AND RELAY CONFIGURATION

Alarm thresholds are set to default levels when shipped, but are configurable. Each Alarm level has its own set of form C relay contacts. As the particulate level crosses the threshold for the alarm level the corresponding indicator will illuminate and the relay will activate. The Alarm thresholds and their associated relay outputs are configurable for latching or non-latching operation. For each alarm level, there is a configurable delay from 0 to 60 seconds. Configurable thresholds for each alarm level are as follows:

TABLE 5. PROGRAMMABLE ALARM LEVELS

ALARM LEVEL	DEFAULT THRESHOLD %OBS/FT	PROG. RANGE % OBS/FT	DEFAULT THRESHOLD %OBS/M	PROG. RANGE %OBS/M
Alert	0.012	0.00046 - 6.0	0.0396	0.0015 - 20.0
Action1	0.050	0.00046 - 6.0	0.165	0.0015 - 20.0
Action2	0.100	0.00046 - 6.0	0.33	0.0015 - 20.0
Fire1	0.250	0.00046 - 6.0	0.825	0.0015 - 20.0
Fire2	0.500	0.00046 - 6.0	1.65	0.0015 - 20.0

AUDIBLE INDICATOR CONFIGURATION

There is a built audible indicator on the FFAST 9400X which gives the option to include a supplementary audible indication of alarms and faults. The settings are configurable using the PipeIQ software. The sounder is capable of generating a pulsed or continuous tone. Both the alarm and fault can be selected to do either tone.

FAILURE OF CONFIGURATION VALIDATION

If configuration validation fails during the configuration process, the software configuration tool will indicate a failure and the device will illuminate the fault indicator. Subsequently, the device will not accept any of the data as valid and will revert back to its previous configuration.

POWER GLITCH DURING CONFIGURATION

During an upload of configuration data, the device will keep the last known good configuration in memory until a complete validation is done on the new configuration data. This prevents device corruption in the event of a power loss or network failure. When power is restored the device will initialize with the last known good configuration. The device will also indicate a Configuration Fault on the user interface and set the Minor Fault Relay. This will only occur once. When the next Reset or Power on Reset is performed the device will continue to use the last known good configuration.

NORMAL

In Normal operating mode the FFAST XT displays the air flow and current particulate levels on the user display. The time, date, address, and current obscuration is shown on the LCD. The particulate level is compared to the threshold levels programmed into the device and will activate the appropriate alarm as the particulate exceeds that threshold. If any fault occurs it will activate the fault LED and display the type on the LCD as well as set the corresponding relay.

TEST

Test mode is initiated through the PipeIQ Live View tab or through the LCD interface. Test mode will simulate a fire condition by activating all ten segments in the Particulate Level display and each segment in the Alarm display. Each corresponding alarm relay will also activate after any programmed delay associated with that relay. To remove the device from test, a RESET must be done.

SOUNDER TEST

The sounder test function can be accessed via the LCD user interface. Upon initiation, the device will exercise the selected sounder tones for fault and alarm conditions. The sounder may be configured to give continuous or pulsed tones for alarm and fault conditions. Tones may be selected using PipeIQ.

RESET

Reset mode is initiated through the PipeIQ mimic view or through the LCD interface. When RESET is activated all relays will be reset. It will then enter Normal mode operation. If any fault or alarm states remain the device will re-activate the state automatically.

RESET AIRFLOW BASELINES

The airflow baselines can be reset through the LCD screen on FFAST’s user interface. Selecting this option will cause the FFAST unit to enter in to a five minute baseline period, which will be displayed on the LCD user interface, and reset its current air flow baselines.



If a high or low condition exists perform a visual inspection of the pipe network to ensure the integrity of the pipe network and that the flow condition is not caused by breakages or blockages.

ISOLATION

From Normal Mode, Isolation mode is initiated through PipeIQ mimic tab or through the LCD interface. The device will set the isolation relay and the isolation fault will be shown on the user interface. The alarm and fault relays will reset and subsequently not change state. In all other respects, the unit will continue to operate normally. Any smoke exceeding alarm thresholds will cause alarm conditions to appear on the detector’s front panel, but the alarm condition will not be communicated to an attached system such as a fire panel. The device will remain in this mode until it is explicitly removed by the user, even in the event of power loss or reset.

DISABLE MODE

The user can initiate Disable Mode through the LCD interface only. When Disable Mode is activated, the device will set the isolation relay and the user interface will display the disable fault. In Disable Mode, the fan will cease operation and the particulate, alarm and airflow displays on the user interface will not be illuminated. The alarm and fault relays will reset and subsequently not change state. This mode should only be used when the system needs to be taken offline. This mode is active indefinitely until the user removes the device from disable mode. All communication interfaces remain active when the device operates in this state.

ACCLIMATE MODE

The FFAST system includes an available Acclimate mode. By allowing the device to operate in Acclimate mode, a device’s susceptibility to nuisance alarms can be reduced. This provides maximum protection for a device located in changing environments. The sensitivity of the unit continuously adjusts over time, within user defined limits, as the environment changes. Acclimate mode must be activated and configured with the PipeIQ software. In Acclimate mode the device automatically adjusts the alarm point between a specified minimum and maximum sensitivity, programmed by the user. For the first 24 hours of operation the device monitors the environment. After the initial 24 hour period, the device adjusts the alarm point based on the particulate levels over a rolling 1 hour period. It then adjusts the alarm level starting from the insensitive boundary, based on the stability of the environment being monitored.

SETTING ACCLIMATE MODE

The user chooses the boundaries for each alarm level in the Acclimate mode. The FFAST system starts from the insensitive boundary and adjusts itself to stay within the sensitive boundary. It is also possible to have static alarm levels by adjusting the high and low boundary to the same level. This allows the flexibility to maintain acclimating levels for some alarms and static levels for others. Table 6 shows the various levels that are available.

Each Acclimate level is also able to be monitored in PipeIQ. This allows the user to read the current Acclimated alarm level for each alarm.

DAY, NIGHT AND WEEKEND MODE

If Acclimate mode is not desired, the FFAST system can operate in a simple day, night and weekend mode. This allows the device to have separate threshold levels for each state. Times can be configured, if desired, for entering and leaving the day and night time operation. The device has an internal time reference (clock) and automatically switches to the weekend mode for Saturday and Sunday.

LOGS

EVENT LOG

The FFAST system is equipped with internal memory that can be configured to log detector events. Up to 18000 events can be stored. Events that are tracked include alarms, faults, and user actions. Event tracking may be accessed via the network through the PipeIQ software or the web server interface. Configuration and management of the log are done using the PipeIQ software.

DATA TREND LOG

The FFAST system can track data from its various sensors in the trend log. Using PipeIQ the frequency of which the data is recorded can be selected to allow higher resolution. The rate is limited to a range of 1 to 60 minute or 1 to 24 hour periods. Depending on the rate chosen, data can be collected for 72 hours up to 11.8 years.

MESSAGE LOG

The message log allows the user to enter generic text messages into the device’s storage memory. Messages may be retrieved for viewing at a later time. These messages may be used to track service history, configuration changes, etc. A maximum of 300 messages may be stored.

EXTERNAL MONITOR/RESET

The FFAST system has an external monitor that can detect an open or a short when the supplied 47 K-ohm end of line resistor is used. When the device senses an open circuit it sets the External Monitor fault indicator and sets the Minor fault relay. When a short circuit is detected the device performs a Reset. This provides the ability to reset alarm latches remotely.

ETHERNET CONNECTION

The FFAST system is a network capable device that is compatible with standard Ethernet networking equipment. Connectivity is provided by an onboard RJ-45 connector located on the bottom of the unit. The network interface is required for initial detector configuration. Once initial setup is complete, the Ethernet connection provides optional remote access, monitoring and e-mail notification through the unit’s Web server and SMTP client.

USB CONNECTION

A USB port is located on the front of the device to allow for configuration and monitoring through PipeIQ or the retrieval of data from the device.

PIPE NETWORK

The unit can monitor up to 28,800 sq.ft. (approx. 2,676 sq. m) with a properly designed pipe network. The pipe network must be properly configured using the PipeIQ software. The pipe network accommodates a maximum single pipe length of 400 ft. (123 m). The device is capable of both metric 25 mm and IPS 1.05 in. pipe outside diameters without the use of an adaptor. The internal pipe diameter can range from .591-.827 inches (15-21mm). The pipe must be installed such that only the top air inlet ports are used or the bottom air inlet ports are used. It is not recommended to mix sampling from the top and bottom ports. Pipe networks may be constructed of various materials such as ABS, cPVC, PVC, copper or stainless steel pipe. Travel time from the furthest hole depends on the application of the device, but is limited to a maximum of 120 seconds by the PipeIQ software. Refer to local agency requirements and PipeIQ software for proper configuration.

TABLE 6. ACCLIMATE LEVELS

ALARM LEVEL	THRESHOLD HIGH SENSITIVITY	THRESHOLD LOW SENSITIVITY	CURRENT LEVEL
Alert	Alert High	Alert Low	Acclimate Alert Level
Action 1	Action 1 High	Action 1 Low	Acclimate Action 1 Level
Action 2	Action 2 High	Action 2 Low	Acclimate Action 2 Level
Fire 1	Fire 1 High	Fire 1 Low	Acclimate Fire 1 Level
Fire 2	Fire 2 High	Fire 2 Low	Acclimate Fire 2 Level

WEB SERVER

The FAAST system contains an integrated Web server which is used to observe detector configuration and may be used to remotely monitor the unit.

The Web server features include:

- Intuitive interface for remote monitoring of faults, relays, particulate level, air flow, and power supply
- Facility location and contact information
- Configuration settings display
- Multi-Lingual support
- Event log viewer

EMAIL NOTIFICATION

The FAAST system has the ability to send e-mail notifications to an individual or organization. Up to 6 different email addresses may be stored for notification. Each email address can be configured to be notified of a specific alarm level, fault level or isolate condition through the PipeIQ software. E-mails from the device indicate a device's ID, location and alarm or fault type. A comprehensive networking guide may be downloaded at systemsensor.com/faast.

CANNED SMOKE TESTING

All FAAST systems must be tested after installation and periodically thereafter. Testing methods must satisfy the authority having jurisdiction. Systems offer maximum performance when tested and maintained in compliance with NFPA 72. UL Tested and approved aerosol smoke products are listed in Table 7.

TABLE 7. CANNED SMOKE TESTING

UL LISTED	COMPANY	AEROSOL
	Home Safeguard	25S
	SDI LLC	CHEK02, CHEK06
		SOLOA3
		SMOKE SABRE-01

MAINTENANCE

The only periodic maintenance required is to replace the filter assembly when the filter light is illuminated. Perform the following procedure to replace the filter assembly.

1. Remove power from the device or system.
2. Open the door that covers the User Interface LED indicators.
3. Remove the plastic name card over the LEDs.
4. Remove the two screws holding the filter assembly into the device.
5. Remove the filter assembly and replace it with a new assembly.
6. Torque the two philips head screws to 6in-lb (0.7 N-M) or ¼ turn past "lightly snug." DO NOT OVERTIGHTEN
7. Replace the plastic name card over the LEDs.
8. Close the door and apply power to the device or system.

Other system checks may need to be performed in accordance with local or national codes and regulations.

LASER SAFETY INFORMATION

This aspiration detector does not produce any hazardous laser radiation and is certified as a Class 1 laser product under the U.S. Department of Health and Human Services (DHHS) Radiation Performance Standard according to the Radiation Control for Health and Safety Act of 1968. Any radiation emitted inside the smoke detector is completely within the protective housings and external covers.

The laser beam cannot escape from the detector during any phase of operation. The Center of Devices and Radiological Health (CDRH) of the U. S. Food and Drug Administration implemented regulations for laser products on August 2, 1976. These regulations apply to laser products manufactured after August 1, 1976. Compliance is mandatory for products marketed in the United States.

WARRANTY

System Sensor warrants its enclosed smoke detector to be free from defects in materials and workmanship under normal use and service for a period of three years from date of manufacture. System Sensor makes no other express warranty for this smoke detector. No agent, representative, dealer, or employee of the Company has the authority to increase or alter the obligations or limitations of this Warranty. The Company's obligation of this Warranty shall be limited to the repair or replacement of any part of the smoke detector which is found to be defective in materials or workmanship under normal use and service during the three year period commencing with the date of manufacture. After phoning System Sensor's toll free number 800-SENSOR2 (736-7672) for a Return Authorization number, send defective units postage prepaid to: System Sensor, Returns

Department, RA # _____, 3825 Ohio Avenue, St. Charles, IL 60174. Please include a note describing the malfunction and suspected cause of failure. The Company shall not be obligated to repair or replace units which are found to be defective because of damage, unreasonable use, modifications, or alterations occurring after the date of manufacture. In no case shall the Company be liable for any consequential or incidental damages for breach of this or any other warranty, expressed or implied whatsoever, even if the loss or damage is caused by the Company's negligence or fault. Some states do not allow the exclusion or limitation of incidental or consequential damages, so the above limitation or exclusion may not apply to you. This Warranty gives you specific legal rights, and you may also have other rights which vary from state to state.

FCC STATEMENT

This device complies with part 15 of the FCC Rules. Operation is subject to the following two conditions: (1) This device may not cause harmful interference, and (2) this device must accept any interference received, including interference that may cause undesired operation.

NOTE: This equipment has been tested and found to comply with the limits for a Class B digital device, pursuant to Part 15 of the FCC Rules. These limits are designed to provide reasonable protection against harmful interference in a residential installation. This equipment generates, uses and can radiate radio frequency energy and, if not installed and used in accordance with the instructions, may cause harmful interference to radio communications. However, there is no guarantee that interference will not occur in a particular installation. If this equipment does cause harmful interference to radio or television reception, which can be determined by turning the equipment off and on, the user is encouraged to try to correct the interference by one or more of the following measures:

- Reorient or relocate the receiving antenna.
- Increase the separation between the equipment and receiver.
- Connect the equipment into an outlet on a circuit different from that to which the receiver is connected.
- Consult the dealer or an experienced radio/TV technician for help.

This Class B digital apparatus complies with Canadian ICES-003.